



# User's Manual

IoT Smart Light Switch

HYUNDAI HT Co., Ltd.



Hello Tomorrow  
Home Think

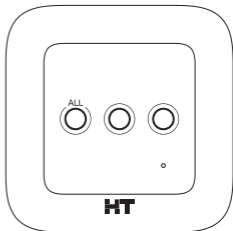

# 01 Precaution for installation

---

- Please make sure to turn power off at the residual-current circuit breaker (RCCB) before installation.  
It may result in serious injury or death.  
If you are unsure or uncomfortable about performing this installation, please consult a qualified electrician.
- Indoor use only.
- Do not touch the switch with wet hands.
- Do not install the switch in where humid or wet place.
- Do not use the damaged switch to avoid any risk of electric shock.
- Do not disassemble, repair and remodel it.
- When removing the existing switch, separate the cut wires using stickers or labels to avoid confusion when reconnecting.
- A loose connection may cause a fire by heat.
- Please check the recommended capacity of the lighting to the switch before installing.  
Ex) Each Gang: 110V X 5A = 550W, 220V X 5A = 1,100W.
- Wrap unused wires with insulation tape to prevent current from flowing.
- Be careful not to touch exposed terminals.

## 02 How to install

---

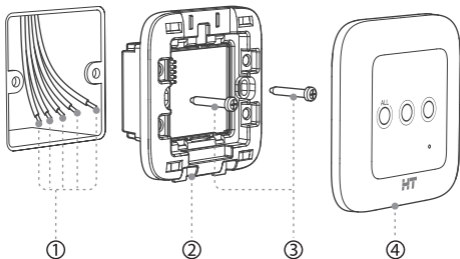

\* Remove the installed existing light switch.

- ① Connect each wire to the main unit by referring to the wiring diagram.
- ② Insert the main unit in the place to install after the wiring is done.
- ③ Fix the main unit with enclosed screws.
- ④ Assemble the front cover and the main unit.

## 03 How to register

---

1. Please refer to the registration of IoT device in a smart host application manual.
2. If the power is supplied to the smart light switch, the third button is started to blink and registration mode is activated.

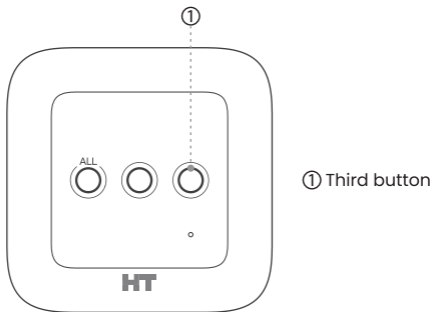

- If the registration is failed, please press and hold the third button to activate the registration mode.

## 04 How to use

---

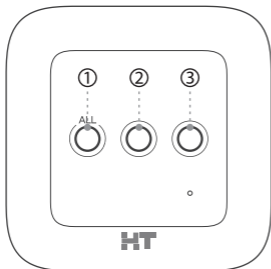

- ① First button
- ② Second button
- ③ Third button

- ① First Button : Turn 1 Gang Lights On/Off  
All Light Off  
(Press and hold for 3 seconds)
- ② Second Button: Turn 2 Gang Lights On/Off
- ③ Third Button : Turn 3 Gang Lights On/Off  
Registration and Deletion on  
HT Home App.  
(Press and hold for 5 seconds)

\* If you press and hold for 5 seconds after registration, the switch is deleted on HT Home App. Please read the smart host application manual carefully to avoid any trouble before deleting.

- If you turn on the light, the button's LED turns off.
- If you turn off the light, the button's LED turns on.

## 05 Wiring Diagram

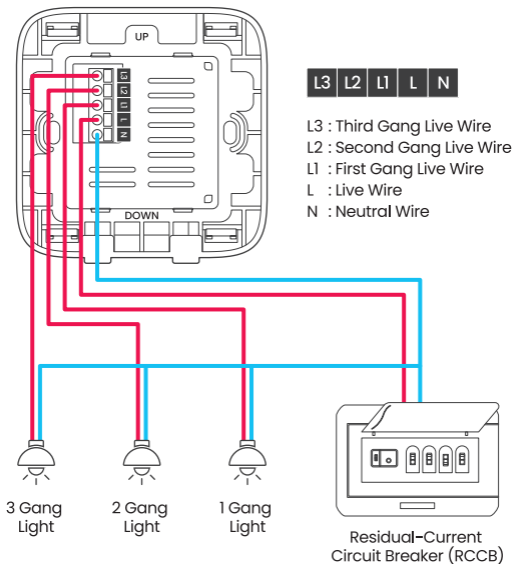

## 06 Components

---

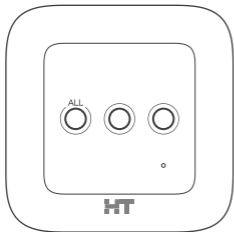

Front Cover

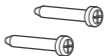

Screw 2pcs

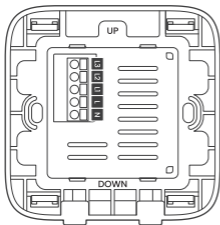

Main Unit



Manual

## 07 Specification

Product	IoT Smart Light Switch
Model	GEZ-SW131-03
Protocol	Zigbee 2.4GHz
Power	AC90~250V 50~60Hz
Size	90mm X 90mm X 43mm
Rated Load	5A (Each Gang) Each Gang: 110V X 5A = 550W, 220V X 5A = 1,100W
Country of Origin	China
Date of Manufacturer	Marked Separately
Serial Number	Marked Separately

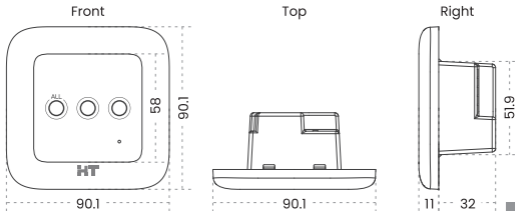

Unit : mm



## Warranty Conditions

**HYUNDAI HT** Products are supplied with \_\_\_\_\_ return to base warranty from the date of purchase, We will repair or replace the defective item with a new or factory rebuilt replacement.

### Condition

1. This warranty applies to the original purchaser only.
2. All warranty will be invalid if unauthorized repair or modification are made to the unit or in any case of accident, misuse and damage cause by improper installation and altered serial numbers.
3. The liability of **HYUNDAI HT** is limited to the cost of repair/replacement of the unit under warranty.
4. If you need a warranty service, you should send the product to our customer service Dept. or dealer office. The product in all cases must be accompanied by the following items :  
Your name, address, telephone number, the serial number and copy of your sales receipt showing the purchase date.

The Model Number is on the box and front of the manual, The Serial Number is on the bottom of the unit, Record the Model and Serial Numbers in the spaces provided below, Refer to these numbers for warranty service.

Model No. \_\_\_\_\_

Serial No. \_\_\_\_\_

## IoT Smart Light Switch



Please scan the QR code  
to see the video clip of how to register.

### **HYUNDAI HT Co., Ltd.**

[www.hyundaiht.co.kr](http://www.hyundaiht.co.kr)

107, Yeouidaebang-ro,

Yeongdeungpo-gu, Seoul, 07433, Korea

(HYUNDAI HT Building, Shingil-dong)

Tel +82.2.2240.9234/9271



6320000335 Rev 00